



**Soft seal Ball valve
Trunnion ball
Flange
PN16-40
DN15-200**

Range of application:

In industrial facilities, oil and chemical industry and related manufacturing industries

Temperature range:

Max. working temperature :
 -29°C to +260°C (carbon steel)
 -50°C to +260°C (stainless steel)
 -196°C acc. to requirement

Perform standard:

Design:split body with full bore round port , floating ball.
 acc. DIN 3357 .
 Design minimum wall thickness calculation acc. : EN12516-1 .
 Face to face : DIN 558-1; Flange ends : DIN EN 1092-1.
 Operating:with a two flat stem acc to the NAMUR-recommends.
 90° -rotary switch
 Actuator mounting: mounting flange acc. to DIN ISO 5211
 for gear box , air- , electric-or hydraulic pattern actuator .
 Fire test : API 607 & BS 6755 .
 TA-Luft 2002 10000 cycles RT.
 TA-Luft acc. to ISO 15848-1 CO2 RT-200°C.
 ISO 15848-1 FE BH CO2 t200°C.
 Antistatic device acc.: BS 5351 .
 Preloaded belleville spring design for stem sealing system,
 offers the possibility of adjustment of the sealing.
 Optional: Ball with relief bore on pressure side (requires unidirectional installation)

Material [according DIN EN (DIN)]

Body: —1.0619N,1.0619QT
 —1.4408,1.4409,1.4539,1.4470
 Ball: —C22.8+ENP
 —1.4401
 —1.4404
 Body Seal: PTFE /Graphite
 Seat: PTFE / RPTFE /TFM1600 / VX1
 / PEEK /PCTFE

FIG.	Pressure	Material	RANGE
133.761	PN16	1.0619N	DN150-DN300
135.761	PN40	1.0619N	DN150-DN300
153.761	PN16	1.4408	DN150-DN300
155.761	PN40	1.4408	DN150-DN300

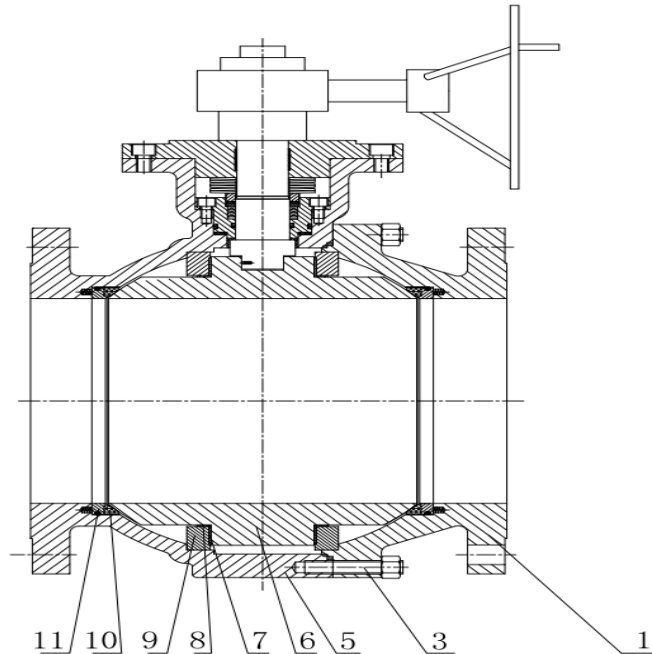

Ball valve with full bore and Flange .

Material list

NO.	Part	Material	
		FIG. 153.761/ 155.761	FIG. 133.761 /135.761
1	Adapter	1.4408	1.0619N
3	Bolts	A4-70	1.7225
5	Body	1.4408	1.0619N
6	Ball	1.4401	C22.8+ENP
7	Thrust bearing	1.4401+PTFE+MoS2	1.4401+PTFE+MoS2
8	Gasket	PTFE	PTFE
9	Bracket	1.4308	C22.8
10	Seat	PTFE/RPTFE/TFM 1600/VX1/ PEEK /PCTFE	PTFE/RPTFE/TFM 1600/VX1/ PEEK /PCTFE
11	Support plate	PTFE	PTFE

STUFFING BOX TYPE :

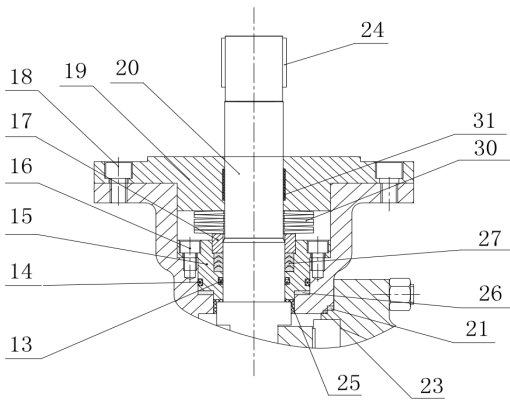

GP(Gland, PTFE)

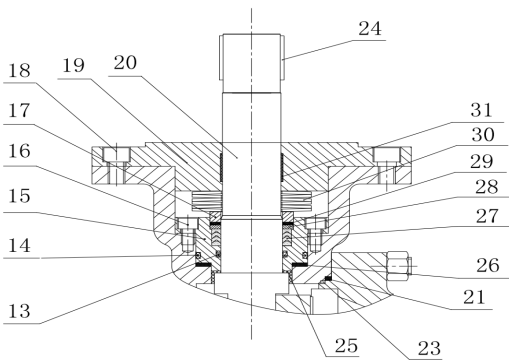

GPG(Gland, PTFE+Graphite)

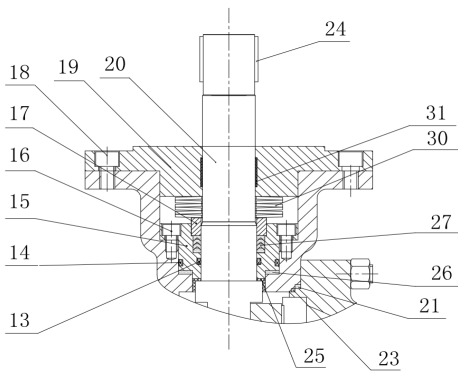

GG(Gland, Graphite)

BODY SEALING TYPE :

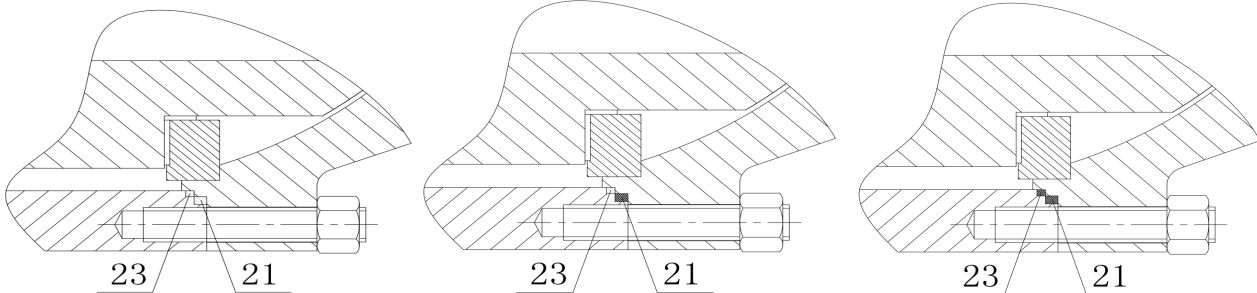

For GP

For GPG

For GG

Material list

NO.	Part	Material		
		Fig.761 GP	Fig.761 GPG	Fig.761 GG
13	O-ring	VITON		
14	O-ring	VITON		
15	Packing-box	1.4408 / C22.8+ENP		
16	Bolts	A4-70 / A2-70		
17	Metal-ring	1.4401 / 1.4301		
18	Bolts	A4-70 / A2-70		
19	Gland	1.4401 / C22.8		
20	Stem	17-4PH/1.4462/1.4571/1.4401		
21	Body seal	PTFE	Graphite	Graphite
23	Body seal	PTFE	PTFE	Graphite
24	Key	45		
25	Gasket	PTFE		
26	Gasket	PTFE	Graphite	Graphite
27	Packing	PTFE	PTFE	Graphite
28	Metal gasket	1.4401/1.4301		
29	Packing		Graphite	
30	Belleville spring	17-7PH		
31	Thrust bearing	1.4401+PTFE+MoS2		

FIG.	Pressure	Material	RANGE
133.761	PN16	1.0619N	DN15-DN200
135.761	PN40	1.0619N	DN15-DN200
153.761	PN16	1.4408	DN15-DN200
155.761	PN40	1.4408	DN15-DN200

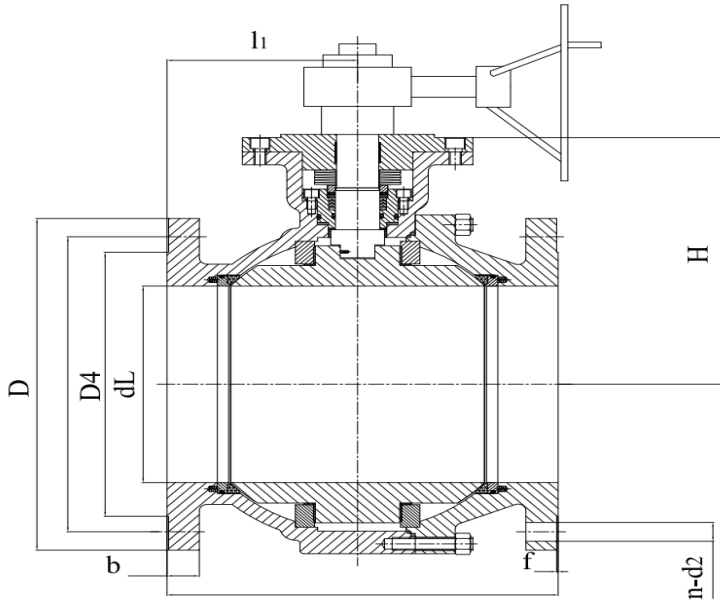

Dimension List

PN	DN	dL	L	L1	H	D	b	k	n-d2	D4×f	Weight
16	150	150	350	124	256	285	22	240	8-Φ22	Φ212×3	
	200	200	400	200	315	340	24	295	12-Φ22	Φ268×3	
	250	250	450	225	316	405	26	355	12-Φ26	Φ320×2	
	300	300	500	240	383	460	28	410	12-Φ26	Φ378×2	
40	150	150	350	124	256	300	28	250	8-Φ26	Φ218×3	
	200	200	400	200	315	375	34	320	12-Φ30	Φ285×3	
	250	250	450	225	316	450	38	385	12-Φ33	Φ345×2	
	300	300	500	240	383	515	42	450	16-Φ33	Φ410×2	

Dimension List

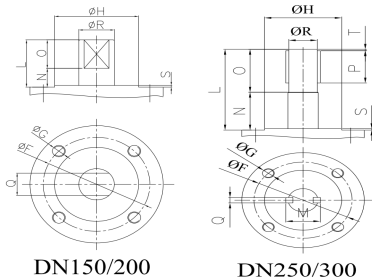

DN	ΦF	ΦG	ΦH	L	O	N	Q	ΦR	S	M	P	T
150	140	M16	100	61	39.8	21.2	20	36	3	-	-	-
200	125	M12	85	61	39.8	21.2	27	50	3	-	-	-
250	165	M20	130	172	90	82	12	50	3	58	70	3
300	254	M16	200	172	90	82	14	55	5	69	70	3

Connecting format

Flanged		
Pressure rating	Flange dimension	Sealing form
PN16 PN40	DIN EN 1092-1	DIN EN 1092-1 Form B 1 Ra max : 12.5 µm Rz max : 50 µm

Installation instructions

Installation site is not prescribed.
Regardless of the flow direction.

Details please consult.

Technical parameters

Flow characteristics - Kv (m³/h)

DN	150	200	250	300
Kv	3500	6500	10200	14700

Open torque - Nm

ΔP (bar)	DN			
	150	200	250	300
0	126	180	321	500
10	233	320	653	989
16	297	450	852	1282
25	393	650	1151	1722
40	553	1010	1648	2455

Maximum and minimum

DN	150	200	250	300
M_{d max}	3500	4800	-	-
M_{d min}	63	90	160	250

Allowable pressure in dependence of the temperature

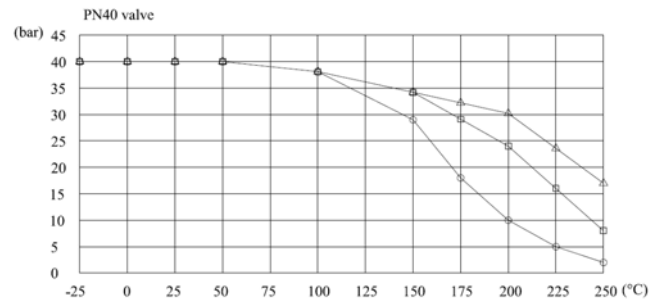
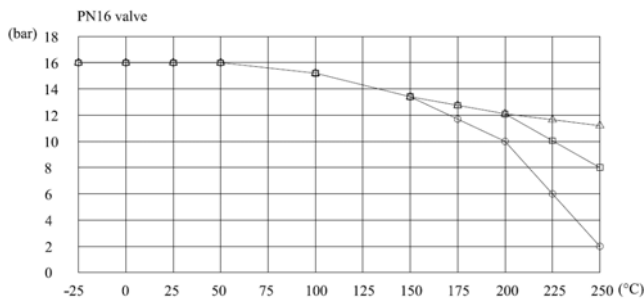

Seat material:

○—○—○ PTFE □—□—□ PTFE+25%Glass △—△—△ PTFE+15%Graphite

The shown values refer to austenitic stainless steel 1.4408. More details please consult.