

Design acc. :
AD 2000 A4
ATEX 2014/34/EU
EN 13709
Face to face : EN558 G1
BW ends : DIN 3239
Test acc. : EN12266
TA-Luft Packing
TA-Luft Gasket
Temperature range :
-29°C to +450°C (1.0619N)
-196°C to +400°C (1.4408)
Body : 1.0619N /1.4408

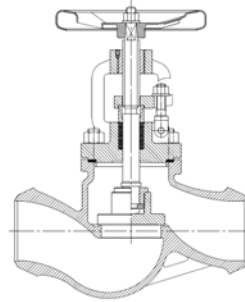
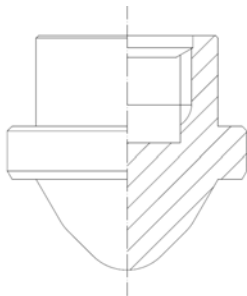

FIG : 121-BW

FIG : 121 - BW

Available



regulating disc

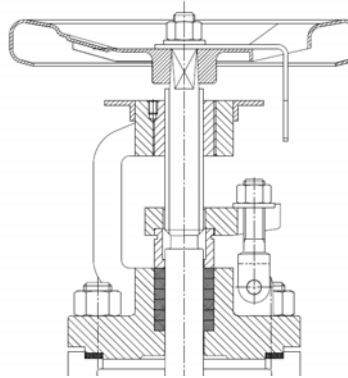

position indicator

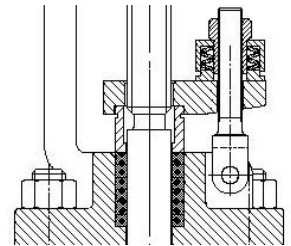

spring load system

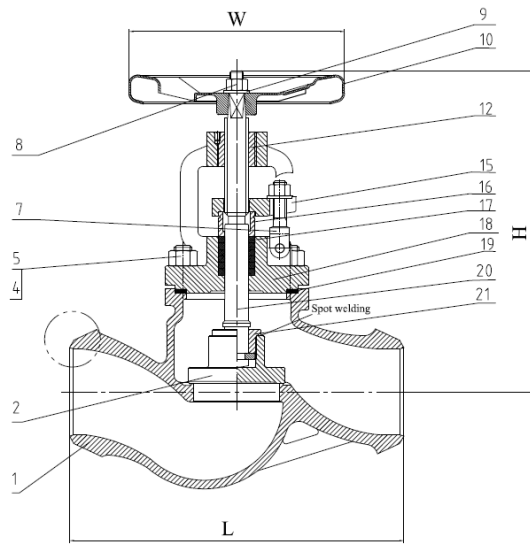
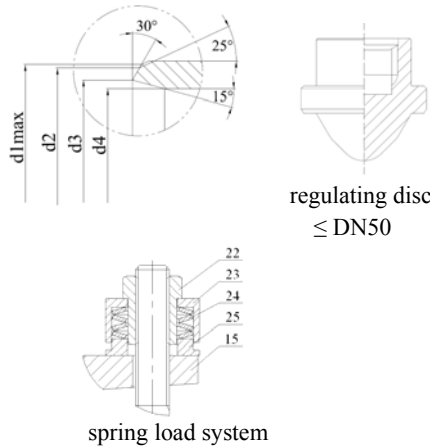

FIG.	Pressure	Material	Range
133.121-BW	PN16	1.0619N	DN15-DN100
135.121-BW	PN40	1.0619N	DN15-DN100
153.121-BW	PN16	1.4408	DN15-DN100
155.121-BW	PN40	1.4408	DN15-DN100



Design acc. :
 AD 2000 A4
 ATEX 2014/34/EU
 EN 13709
 Face to face : EN558 G1
 BW ends : DIN 3239
 Test acc. : EN12266-1
 TA-Luft Packing
 TA-Luft Gasket
 Temperature range :
 -29°C to +450°C (1.0619N)
 -196°C to +400°C (1.4408)

Material List

NO.	Part	Material	
		FIG.133.121 - BW / 135.121 - BW	FIG.153.121 - BW / 155.121 - BW
1	Body	1.0619N+13Cr	1.4408
2	Disk	1.4021	1.4401
4	Bolt	1.7225 (GC)	A4-70/A2-70
5	Nut	1.1181(YK)	A4-70/A2-70
7	Bolt	35	1.4571
8	Nut	35	A2-70
9	Gasket	35	1.4408
10	Handwheel	C10E	C10E
12	Yoke nut	0.7040	0.7040
15	Gland	1.0619N	1.4408
16	Packing gland	1.4021	1.4401
17	Packing	TA-Luft Packing	TA-Luft Packing
18	Bonnet	1.0619N	1.4408
19	Body seal	TA Luft Gasket	TA Luft Gasket
20	Stem	1.4021	1.4571
21	Disc nut	1.4301	1.4401
22	Nut	1.4006	1.4401
23	Cover	1.4006	1.4401
24	Spring	51CrV4	51CrV4
25	Gasket	1.4006	1.4401

Dimension List

PN	DN	L	d1max	d2	d3	d4	W	H	Hub	Weight(KG)
16	65	290	83	78	70	65	180	310	15	18.2
	80	310	96	91	82	80	200	374	25	21.3
	100	350	121	116	106	100	225	377	25	46.3
16/40	15	130	24	23	17	15	120	232	6	2.8
	20	150	31	28	22	20	120	232	6	3.1
	25	160	37	34	28	25	140	245	8	4.7
	32	180	43	42	35	32	140	245	8	4.9
	40	200	54	50	43	40	160	295	15	8.3
40	65	290	83	78	70	65	180	310	15	18.2
	80	310	96	91	82	80	200	374	25	21.3
	100	350	121	116	106	100	225	377	25	46.3

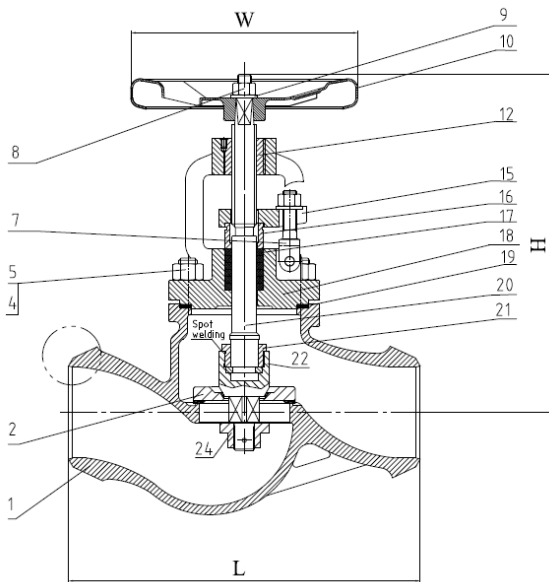
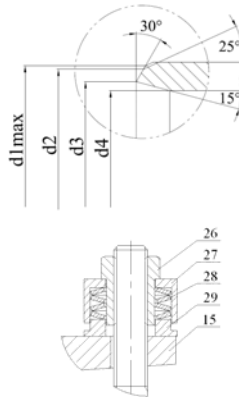

FIG.	Pressure	Material	Range
133.121-BW	PN16	1.0619N	DN125-DN300
135.121-BW	PN40	1.0619N	DN125-DN300
153.121-BW	PN16	1.4408	DN125-DN300
155.121-BW	PN40	1.4408	DN125-DN300



Design acc. :
AD 2000 A4
ATEX 2014/34/EU
EN 13709
Face to face : EN558 G1
BW ends : DIN 3239
Test acc. : EN12266-1
TA-Luft Packing & Gasket
Temperature range :
-29°C to +450°C (1.0619N)
-196°C to +400°C (1.4408)

spring load system

Material List

NO.	Part	Material	
		FIG.133.121 - BW / 135.121 - BW	FIG.153.121 - BW / 155.121 - BW
1	Body	1.0619N+13Cr	1.4408
2	Disk	C25(forge)+13Cr	1.4401
4	Bolt	1.7225 (GC)	A4-70/A2-70
5	Nut	1.1181 (YK)	A4-70/A2-70
7	Bolt	35	1.4571
8	Nut	35	A2-70
9	Gasket	35	1.4408
10	Handwheel	C10E	C10E
12	Yoke nut	0.7040	0.7040
15	Gland	1.0619N	1.4408
16	Packing gland	1.4021	1.4401
17	Packing	TA-Luft Packing	TA-Luft Packing
18	Bonnet	1.0619N	1.4408
19	Gasket	TA-Luft Gasket	TA-Luft Gasket
20	Stem	1.4021	1.4571
21	Disc nut	1.4021	1.4401
22	Secondary disc	1.4021	1.4401
24	Nut	A2	A4
26	Nut	1.4006	1.4401
27	Cover	1.4006	1.4401
28	Spring	51CrV4	51CrV4
29	Gasket	1.4006	1.4401

Dimension List

PN	DN	L	d1max	d2	d3	d4	W	H	Weight(KG)
16	125	400	147	142	131	125	225	448	59.6
	150	480	176	171	159	150	300	470	99.5
	200	600	228	222	207	200	400	570	169.6
	250	730	282	276	260	250	500	780	317
	300	850	331	325	309	300	550	890	447.2
	350	980	365	359	341	350	750	1010	630.8
40	125	400	147	142	131	125	225	448	59.6
	150	480	176	171	159	150	300	470	99.5
	200	600	228	222	207	200	400	570	169.6
	250	730	282	276	260	250	400	625	317
	300	850	331	325	309	300	-	-	447.2