

Design acc. :
AD 2000 A4,ATEX 2014/34/EU,EN 1984.
Face to face : EN558-1 Ser.15/Ser.26
BW ends : DIN 3239.
Test acc. : EN12266.
Temperature range :
 -29°C~ +450°C(1.0619N)
 -196°C~ +400°C(1.4408)
Body : 1.0619N /1.4408

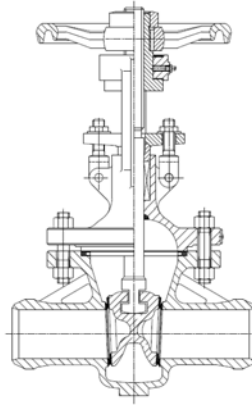
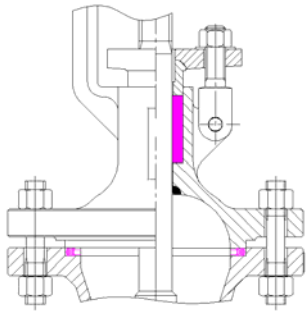
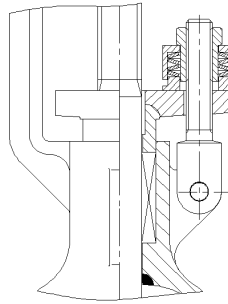

FIG: 031-BW

Available



TA Luft gasket and TA Luft Packing



TA Luft gasket and TA Luft Packing with spring load system

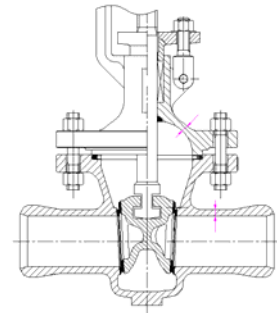

Wall thickness acc.to 300 lbs for PN16 and PN25 valves

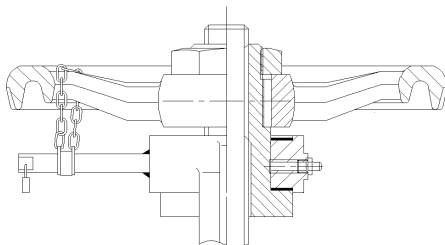

Locking device

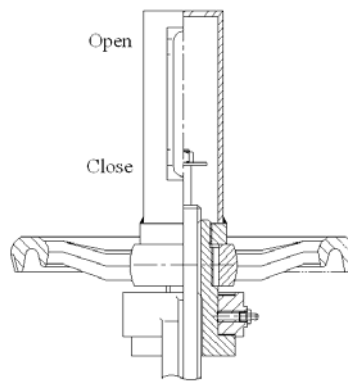

Position indicator

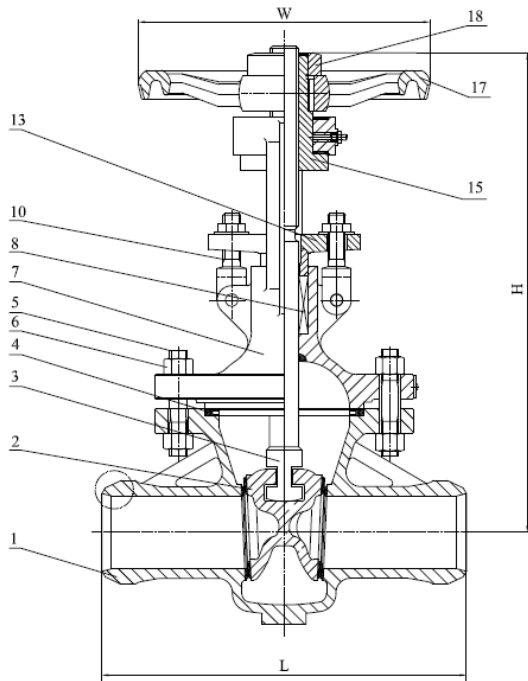

FIG.	Pressure	Material	Range
133.031 - BW	PN16	1.0619N	DN50-DN125
134.031 - BW	PN25	1.0619N	DN50-DN125
153.031 - BW	PN16	1.4408	DN50-DN125
154.031 - BW	PN25	1.4408	DN50-DN125

Design and manufacture acc. :

AD 2000 A4

ATEX 2014/34/EU

EN 1984.

Face to face : EN558-1 Ser.15

BW ends : DIN 3239.

Test acc. : EN12266.

Temperature range :

-29°C ~ +450°C (1.0619N)

-196°C ~ +400°C (1.4408)

Material list

NO.	Part	Material	
		FIG. 153.031 - BW / 154.031 - BW	FIG. 133.031 - BW / 134.031 - BW
1	Body	1.4408 / 1.4408 + STL (>DN100)	1.0619N+13Cr
2	Wedge	1.4408	1.0619N+13Cr / 1.4006(≤DN100)
3	Stem	1.4401	1.4021
4	Body seal	1.4401+Graphite	1.4301+Graphite
5	Bolts	A4-70/A2-70	1.7225(GC)
6	Nut	A4-70/A2-70	1.1181(YK)
7	Bonnet	1.4408	1.0619N
8	Packing	Graphite	Graphite
10	Fork bolt	A4-70/A2-70	1.7225(GC)
13	Gland flange	1.4408	1.0619N
15	Stem nut	GGG 40.3	GGG 40.3
17	Handwheel	GGG 40.3	GGG 40.3
18	Lock nut	1.4021	1.1181

Dimension list

PN	DN	L	D1	d1max	d2	d3	d4	H	W	Stem	Torque (N.m)	Number of turn	Hub	WT. (KG)	FTF
16	65	270	122	83	78	70	65	425	250	Tr24×5LH	40	17	85	32.9	Ser.15
	80	280	138	96	91	82	80	420	250	Tr24×5LH	45	19	95	34.3	
	100	300	158	121	116	106	100	480	250	Tr26×5LH	50	23	115	49.9	
	125	325	188	147	142	131	125	590	350	Tr26×5LH	80	29	145	69.9	
25	65	270	122	83	78	70	65	425	250	Tr24×5LH	40	17	85	32.9	
	80	280	138	96	91	82	80	420	250	Tr24×5LH	45	19	95	34.8	
	100	300	162	121	116	106	100	500	250	Tr26×5LH	50	23	115	50	
	125	325	188	147	142	131	125	590	350	Tr26×5LH	80	29	145	69.9	
16/25	50	250	102	67	62	54	50	340	200	Tr20×4LH	35	15	60	23.1	

Note: The torque in the table does not contain safety factor.

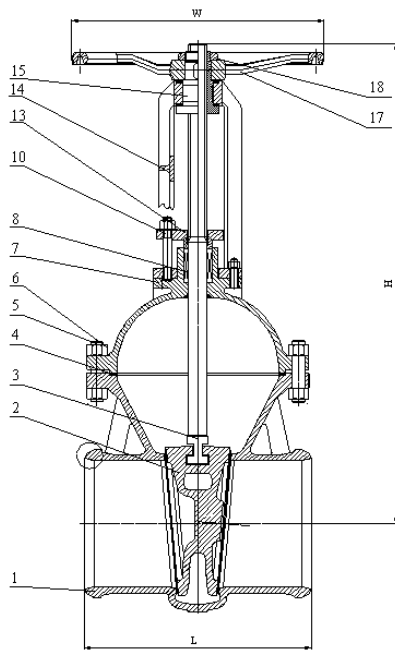
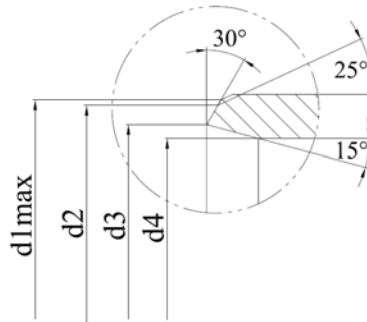

FIG.	Pressure	Material	Range
133.031 - BW	PN16	1.0619N	DN150-DN500
153.031 - BW	PN16	1.4408	DN150-DN500

Design and manufacture acc. :
AD 2000 A4
ATEX 2014/34/EU
EN 1984.
Face to face : EN558-1 Ser.15
BW ends : DIN 3239.
Test acc. : EN12266.
Temperature range :
-29°C ~ +450°C (1.0619N)
-196°C ~ +400°C (1.4408)



Material list

NO.	Part	Material	
		FIG. 153.031 - BW	FIG. 133.031 - BW
1	Body	1.4408 + STL	1.0619N+13Cr
2	Wedge	1.4408	1.0619N +13Cr / 1.4006(≤DN100)
3	Stem	1.4401	1.4021
4	Body seal	1.4401+Graphite	1.4301+Graphite
5	Bolts	A4-70/A2-70	1.7225(GC)
6	Nut	A4-70/A2-70	1.1181(YK)
7	Bonnet	1.4408	1.0619N
8	Packing	Graphite	Graphite
10	Bolt	A4-70/A2-70	1.7225(GC)
13	Gland flange	1.4408	1.0619N
14	Yoke	1.4408	1.0619N
15	Stem nut	GGG 40.3	GGG 40.3
17	Handwheel	GGG 40.3	GGG 40.3
18	Lock nut	1.4021	1.1181

Dimension list

PN	DN	L	d1max	d2	d3	d4	H	W	Stem	Torque (N.m)	Number of turn	Hub	WT. (KG)	FTF
16	150	350	176	171	159	150	670	400	Tr28×5LH	90	34	170	97.5	Ser.15
	200	400	228	222	207	200	830	400	Tr32×6LH	150	36	216	138.6	
	250	450	282	276	260	250	955	450	Tr36×6LH	200	46	276	242	
	300	500	331	325	309	300	1145	500	Tr40×7LH	310	46	322	381.2	
	350	550	365	359	341	350	1210	500	Tr40×7LH	400	53	371	396.8	
	400	600	417	411	387	400	1390	600	Tr44×8LH	450	53	424	592	
	500	700	518	512	482	500	1730	700	Tr50×8LH	700	67	536	939	

Note: The torque in the table does not contain safety factor.

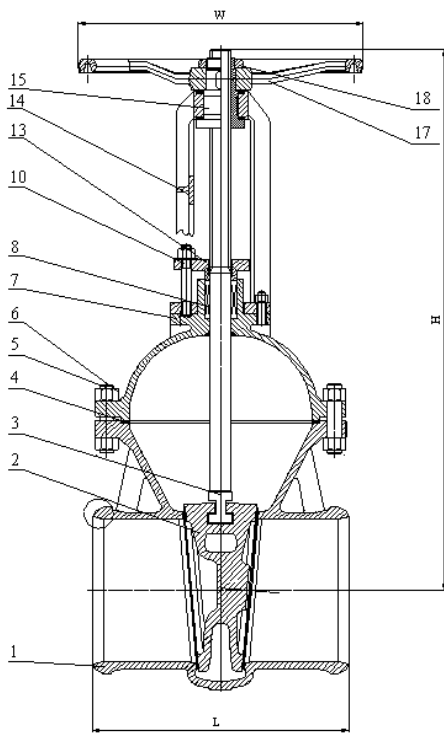

FIG.	Pressure	Material	Range
134.031 - BW	PN25	1.0619N	DN150-DN500
154.031 - BW	PN25	1.4408	DN150-DN500

Design and manufacture acc. :

AD 2000 A4

ATEX 2014/34/EU

EN 1984.

Face to face : EN558-1 Ser.15

BW ends : DIN 3239.

Test acc. : EN12266.

Temperature range :

-29°C ~ +450°C (1.0619N)

-196°C ~ +400°C (1.4408)

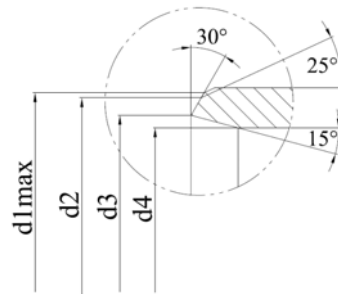

Material list

NO.	Part	Material	
		FIG. 154.031 - BW	FIG. 134.031 - BW
1	Body	1.4408 + STL	1.0619N+13Cr
2	Wedge	1.4408	1.0619N+13Cr / 1.4006(≤DN100)
3	Stem	1.4401	1.4021
4	Body seal	1.4401+Graphite	1.4301+Graphite
5	Bolts	A4-70/A2-70	1.7225(GC)
6	Nut	A4-70/A2-70	1.1181(YK)
7	Bonnet	1.4408	1.0619N
8	Packing	Graphite	Graphite
10	Bolt	A4-70/A2-70	1.7225(GC)
13	Gland flange	1.4408	1.0619N
14	Yoke	1.4408	1.0619N
15	Stem nut	GGG 40.3	GGG 40.3
17	Handwheel	GGG 40.3	GGG 40.3
18	Lock nut	1.4021	1.1181

Dimension list

PN	DN	L	d1 max	d2	d3	d4	H	W	Stem	Torque (N.m)	Number of turn	Hub	WT. (KG)	FTF
25	150	350	176	171	159	150	670	400	Tr28×5LH	90	34	170	100	Ser.15
	200	400	228	222	207	200	830	400	Tr32×6LH	160	36	216	138.6	
	250	450	282	276	260	250	955	450	Tr36×6LH	220	46	276	242	
	300	500	331	325	309	300	1145	500	Tr40×7LH	330	46	322	381.2	
	350	550	365	359	341	350	1210	500	Tr40×7LH	420	53	371	396.8	
	400	600	417	411	387	400	1390	600	Tr44×8LH	500	53	424	593	
	500	700	518	512	482	500	1730	700	Tr50×8LH	750	67	536	945	

Note: The torque in the table does not contain safety factor.

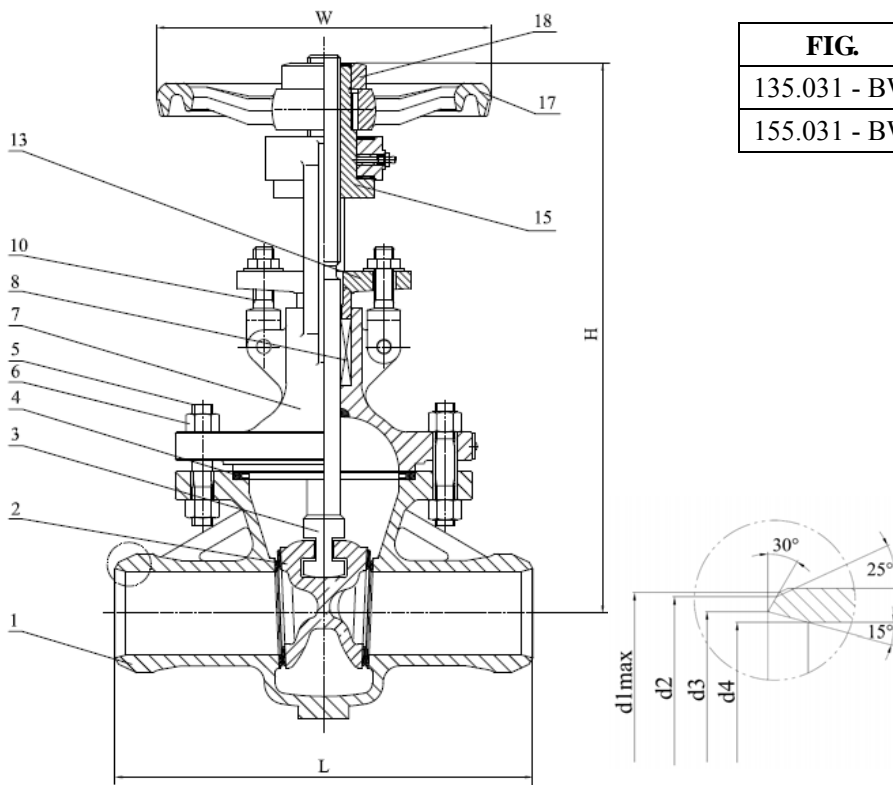

FIG.	Pressure	Material	Range
135.031 - BW	PN40	1.0619N	DN50-DN125
155.031 - BW	PN40	1.4408	DN50-DN125

Design and manufacture acc. :
AD 2000 A4
ATEX 2014/34/EU
EN 1984.
Face to face : EN558-1 Ser.26
BW ends : DIN 3239.
Test acc. : EN12266.
Temperature range :
-29°C~ +450°C(1.0619N)
-196°C~ +400°C(1.4408)

Material list

NO.	Part	Material	
		FIG. 155.031 - BW	FIG. 135.031 - BW
1	Body	1.4408 / 1.4408 + STL (>DN100)	1.0619N+13Cr
2	Wedge	1.4408	1.0619N +13Cr / 1.4006(≤DN100)
3	Stem	1.4401	1.4021
4	Body seal	1.4401+Graphite	1.4301+Graphite
5	Bolts	A4-70/A2-70	1.7225(GC)
6	Nut	A4-70/A2-70	1.1181(YK)
7	Bonnet	1.4408	1.0619N
8	Packing	Graphite	Graphite
10	Fork bolt	A4-70/A2-70	1.7225(GC)
13	Gland flange	1.4408	1.0619N
15	Stem nut	GGG 40.3	GGG 40.3
17	Handwheel	GGG 40.3	GGG 40.3
18	Lock nut	1.4021	1.1181

Dimension list

PN	DN	L	d1max	d2	d3	d4	H	W	Stem	Torque (N.m)	Number of turn	Hub	WT. (KG)	FTF
40	50	250	67	62	54	50	340	200	Tr20×4LH	35	15	60	23.1	Ser.26
	65	290	83	78	70	65	415	250	Tr24×5LH	40	17	85	34.1	
	80	310	96	91	82	80	420	250	Tr24×5LH	50	19	95	36.6	
	100	350	121	116	106	100	485	250	Tr26×5LH	55	23	115	55	
	125	400	147	142	131	125	590	350	Tr26×5LH	90	29	145	76	

Note: The torque in the table does not contain safety factor.

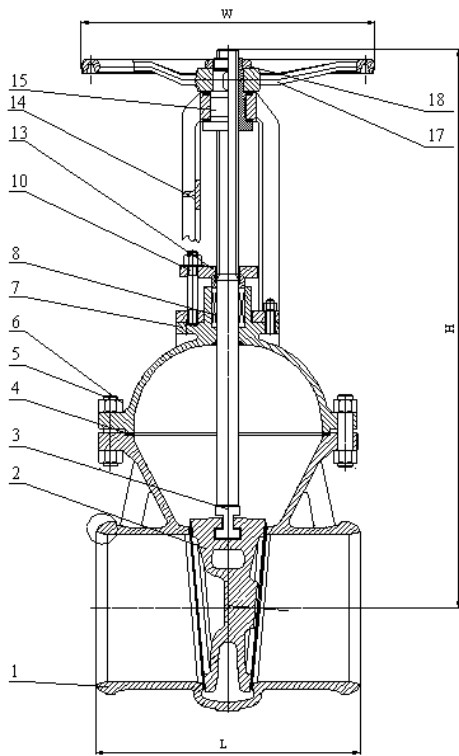

FIG.	Pressure	Material	Range
135.031 - BW	PN40	1.0619N	DN150-DN500
155.031 - BW	PN40	1.4408	DN150-DN500

Design and manufacture acc. :

AD 2000 A4

ATEX 2014/34/EU

EN 1984.

Face to face : EN558-1 Ser.26

BW ends : DIN 3239.

Test acc. : EN12266.

Temperature range :

-29°C ~ +450°C (1.0619N)

-196°C ~ +400°C (1.4408)

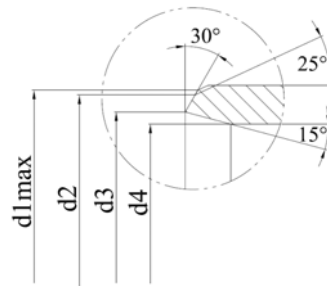

Material list

NO.	Part	Material	
		FIG. 155.031 - BW	FIG. 135.031 - BW
1	Body	1.4408 + STL	1.0619N+13Cr
2	Wedge	1.4408	1.0619N +13Cr / 1.4006(≤DN100)
3	Stem	1.4401	1.4021
4	Body seal	1.4401+Graphite	1.4301+Graphite
5	Bolts	A4-70/A2-70	1.7225(GC)
6	Nut	A4-70/A2-70	1.1181(YK)
7	Bonnet	1.4408	1.0619N
8	Packing	Graphite	Graphite
10	Bolt	A4-70/A2-70	1.7225(GC)
13	Gland flange	1.4408	1.0619N
14	Yoke	1.4408	1.0619N
15	Stem nut	GGG 40.3	GGG 40.3
17	Handwheel	GGG 40.3	GGG 40.3
18	Lock nut	1.4021	1.1181

Dimension list

PN	DN	L	d1max	d2	d3	d4	H	W	Stem	Torque (N.m)	Number of turn	Hub	WT. (KG)	FTF
40	150	450	176	171	159	150	670	400	Tr28×5LH	100	34	170	103.6	Ser.26
	200	550	228	222	207	200	830	400	Tr32×6LH	170	36	216	171	
	250	650	282	276	260	250	955	450	Tr36×6LH	230	46	276	299	
	300	750	331	325	309	300	1145	500	Tr44×8LH	350	40	320	445	

Note: The torque in the table does not contain safety factor.