

DIN High-pressure gate valve**Fig.036,037,038****DN50-DN400****PN63,PN100,PN160****Body:1.0619N,1.7357,1.7379,1.4408****Design features**

- Round body, Outside screw and yoke, Rising stem, Non rising handwheel, Flexible wedge
- Pressure self-sealing bonnet or bolted bonnet for PN160
- ANSI version connection available: ASME B16.5 flanged end, ASME B16.25 Butt welded end
- Fire safe per EN ISO 10497 applicable

Applications

Fig.036.037.038 is design guarantees reliable and excellent protections against leaks and severe condition. The valve is suitable for water, gas, oil and other non aggressive media depending on body material. The fields of application are chemical and petrochemical industries, power plants, ship building and other.

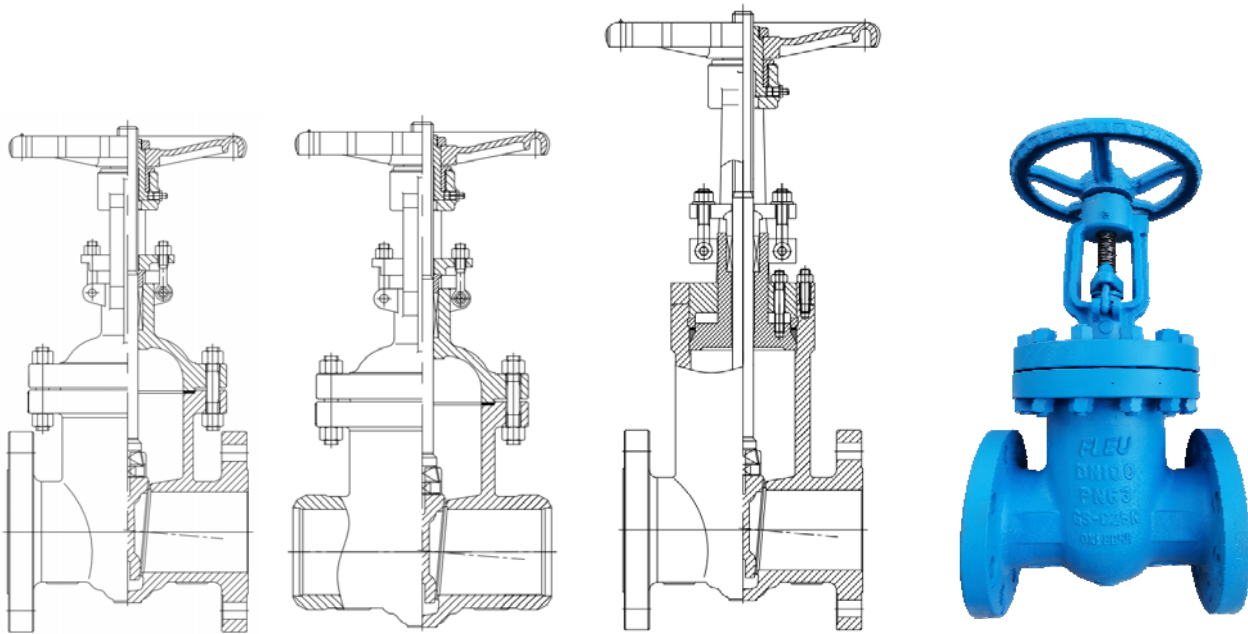
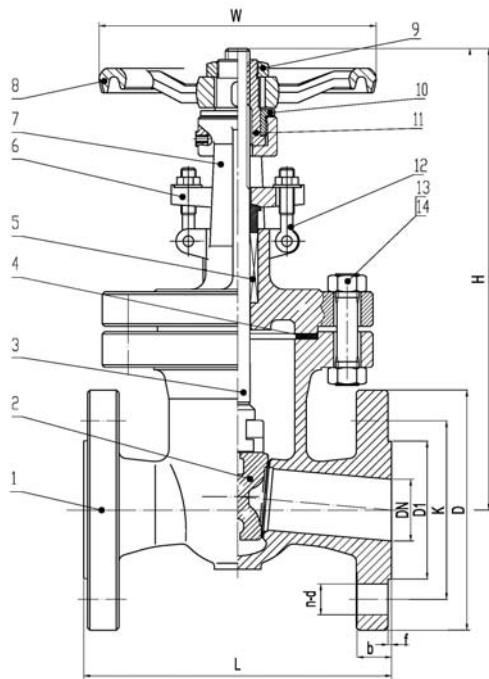

FIG.	Pressure	Material	Range
136.036	PN63	1.0619N	DN50-DN400
176.036	PN63	1.7357	DN50-DN400
536.036	PN63	1.7379	DN50-DN400
156.036	PN63	1.4408	DN50-DN400

Design and manufacture acc. :
AD 2000 A4
ATEX 2014/34/EU
DIN EN 1984
Face to face : DIN EN 558-1,Ser.26(F7)
Flange end : DIN EN 1092-1.
Test acc. : DIN EN 12266.

Material list

NO.	Part	Material			
		FIG. 136.036	FIG. 176.036	FIG.536.036	FIG.156.036
1	Body	1.0619N	1.7357	1.7379	1.4408
1.1	Body seat	13%Cr/Stellite	13%Cr/Stellite	13%Cr/Stellite	1.4408/Stellite
2	Wedge	1.0619N	1.7357	1.7379	1.4408
2.2	Wedge seat	13%Cr/Stellite	13%Cr/Stellite	13%Cr/Stellite	1.4408/Stellite
3	Stem	1.4021	1.4021	1.4021	1.4401
4	Gasket	1.4301+ Graphite	1.4301+ Graphite	1.4301+ Graphite	1.4401+ Graphite
5	Bonnet	1.0619N	1.7357	1.7379	1.4408
6	Nut	1.1181	1.7218	1.7218	A4
7	Bolt	1.7225	1.7709	1.7709	A4-70
8	Packing	Graphite	Graphite	Graphite	Graphite
9	Packing gland	1.0619N	1.7357	1.7379	1.4408
10	Gland nut	1.1181	1.7218	1.7218	A4
11	Eyelet bolt	1.7225	1.7709	1.7709	A4-70
12	Stem nut	GGG 40.3	GGG 40.3	GGG 40.3	GGG 40.3
13	Gland	1.0460	1.0460	1.0460	1.0460
14	Handwheel	GGG 40.3	GGG 40.3	GGG 40.3	GGG 40.3

Dimension list

PN	DN	L	D	K	D1	f	b	n	d	W
63	50	250	180	135	102	3	26	4	22	200
	65	290	205	160	122	3	26	8	22	250
	80	310	215	170	138	3	28	8	22	250
	100	350	250	200	162	3	30	8	26	400
	150	450	345	280	218	3	36	8	33	500
	200	550	415	345	285	3	42	12	36	600
	250	650	470	400	345	3	46	12	36	700
	300	750	530	460	410	4	52	16	36	700
	350	850	600	525	465	4	56	16	39	800
	400	950	670	585	535	4	60	16	42	1000

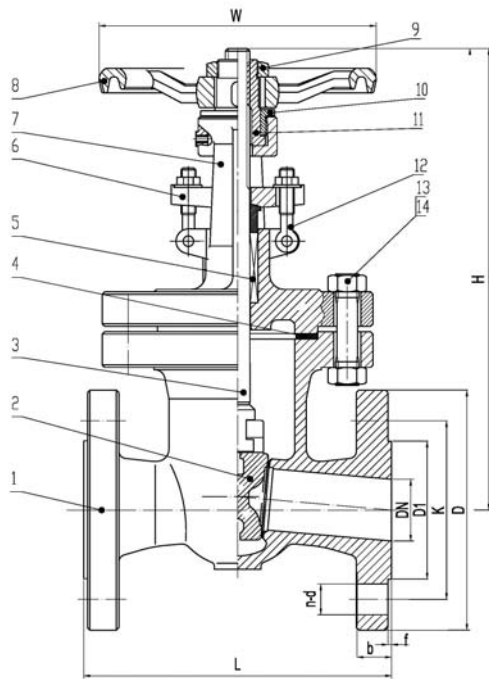

FIG.	Pressure	Material	Range
136.037	PN100	1.0619N	DN50-DN400
176.037	PN100	1.7357	DN50-DN400
536.037	PN100	1.7379	DN50-DN400
156.037	PN100	1.4408	DN50-DN400

Design and manufacture acc. :
AD 2000 A4
ATEX 2014/34/EU
DIN EN 1984
Face to face : DIN EN 558-1,Ser.26(F7)
Flange end : DIN EN 1092-1.
Test acc. : DIN EN 12266.

Material list

NO.	Part	Material			
		FIG. 137.037	FIG. 177.037	FIG.537.037	FIG.157.037
1	Body	1.0619N	1.7357	1.7379	1.4408
1.1	Body seat	13%Cr/Stellite	13%Cr/Stellite	13%Cr/Stellite	1.4408/Stellite
2	Wedge	1.0619N	1.7357	1.7379	1.4408
2.2	Wedge seat	13%Cr/Stellite	13%Cr/Stellite	13%Cr/Stellite	1.4408/Stellite
3	Stem	1.4021	1.4021	1.4021	1.4401
4	Gasket	1.4301+ Graphite	1.4301+ Graphite	1.4301+ Graphite	1.4401+ Graphite
5	Bonnet	1.0619N	1.7357	1.7379	1.4408
6	Nut	1.1181	1.7218	1.7218	A4
7	Bolt	1.7225	1.7709	1.7709	A4-70
8	Packing	Graphite	Graphite	Graphite	Graphite
9	Packing gland	1.0619N	1.7357	1.7379	1.4408
10	Gland nut	1.1181	1.7218	1.7218	A4
11	Eyelet bolt	1.7225	1.7709	1.7709	A4-70
12	Stem nut	GGG 40.3	GGG 40.3	GGG 40.3	GGG 40.3
13	Gland	1.0460	1.0460	1.0460	1.0460
14	Handwheel	GGG 40.3	GGG 40.3	GGG 40.3	GGG 40.3

Dimension list

PN	DN	L	D	K	D1	f	b	n	d	W
100	50	250	195	145	102	3	30	4	26	200
	65	290	220	170	122	3	34	8	26	250
	80	310	230	180	138	3	36	8	26	250
	100	350	265	210	162	3	40	8	30	400
	150	450	355	290	218	3	36	12	33	500
	200	550	430	360	285	3	42	12	36	600
	250	650	505	430	345	3	46	12	39	700
	300	750	585	500	410	4	52	16	42	700
	350	850	655	560	465	4	56	16	39	800
	400	950	715	620	535	4	64	16	48	1000

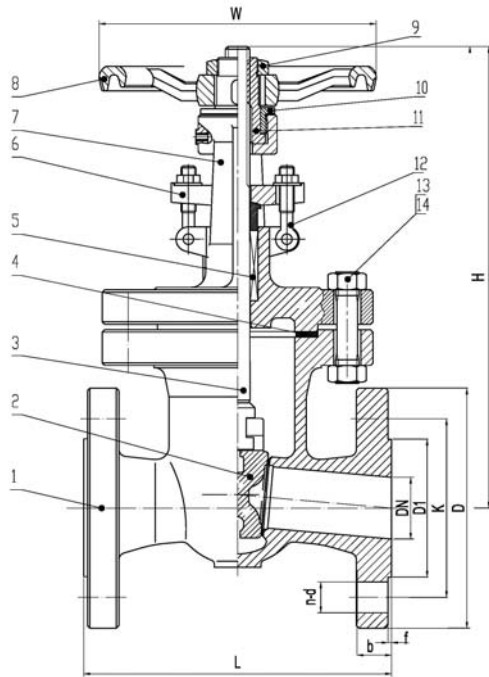

FIG.	Pressure	Material	Range
138.038	PN160	1.0619N	DN50-DN300
178.038	PN160	1.7357	DN50-DN300
538.038	PN160	1.7379	DN50-DN300
158.038	PN160	1.4408	DN50-DN300

Design and manufacture acc. :
AD 2000 A4
ATEX 2014/34/EU
DIN EN 1984
Face to face : DIN EN 558-1,Ser.99(F8)
Flange end : DIN EN 1092-1.
Test acc. : DIN EN 12266.

Material list

NO.	Part	Material			
		FIG. 138.038	FIG. 178.038	FIG.538.038	FIG.158.038
1	Body	1.0619N	1.7357	1.7379	1.4408
1.1	Body seat	13%Cr/Stellite	13%Cr/Stellite	13%Cr/Stellite	1.4408/Stellite
2	Wedge	1.0619N	1.7357	1.7379	1.4408
2.2	Wedge seat	13%Cr/Stellite	13%Cr/Stellite	13%Cr/Stellite	1.4408/Stellite
3	Stem	1.4021	1.4021	1.4021	1.4401
4	Gasket	1.4301+ Graphite	1.4301+ Graphite	1.4301+ Graphite	1.4401+ Graphite
5	Bonnet	1.0619N	1.7357	1.7379	1.4408
6	Nut	1.1181	1.7218	1.7218	A4
7	Bonnet	1.7225	1.7709	1.7709	A4-70
8	Packing	Graphite	Graphite	Graphite	Graphite
9	Packing gland	1.0619N	1.7357	1.7379	1.4408
10	Gland nut	1.1181	1.7218	1.7218	A4
11	Eyelet bolt	1.7225	1.7709	1.7709	A4-70
12	Stem nut	GGG 40.3	GGG 40.3	GGG 40.3	GGG 40.3
13	Gland	1.0460	1.0460	1.0460	1.0460
14	Handwheel	GGG 40.3	GGG 40.3	GGG 40.3	GGG 40.3

Dimension list

PN	DN	L	D	K	D1	f	b	n	d	W
160	50	300	195	145	102	3	30	4	26	200
	65	360	220	170	122	3	34	8	26	250
	80	390	230	180	138	3	36	8	26	250
	100	450	265	210	162	3	40	8	30	400
	150	600	355	290	218	3	50	12	33	500
	200	750	430	360	285	3	60	12	36	600
	250	900	515	430	345	3	68	12	42	700
	300	1050	585	500	410	4	78	16	42	700

Available

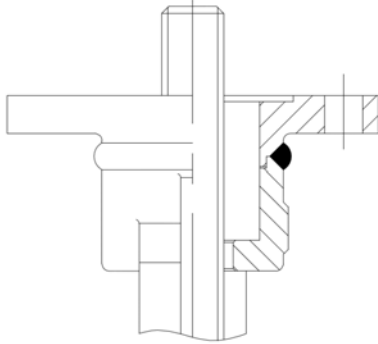

ISO top flange

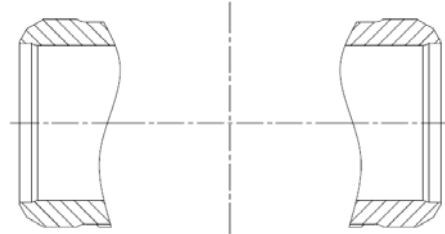

BW end acc. to EN 12627 & ASME B16.25

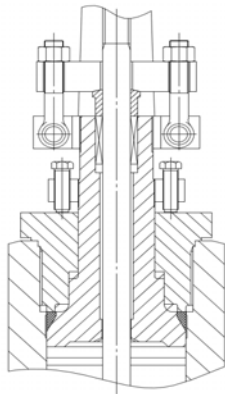

Pressure self-sealing bonnet for PN160

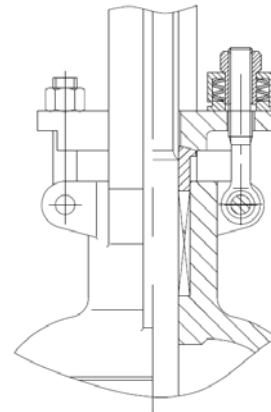

Spring living loaded system of packing