

Class : 300LB
Design acc. : API 600 .
Face to face : ASME B16.10 .
Flange ends : ASME B16.5 .
Pressure text : API 598 .
TA-Luft Packing
TA-Luft Gasket
Temperature range :
-29°C~ +425°C (ASTM A216 WCB)
Body : ASTM A216 WCB

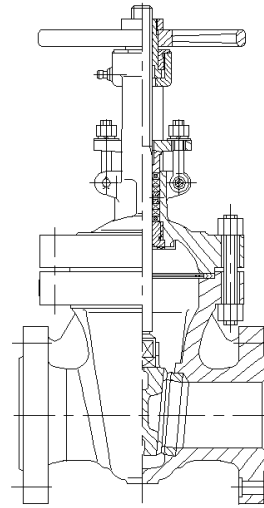

Available: Packing box spring loading system acc. to ISO 15848-1

Packing box spring loading
system acc. to ISO
15848-1(for 8" and larger)

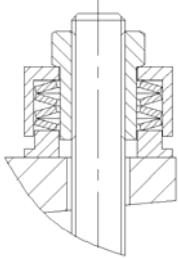

FIG : 041

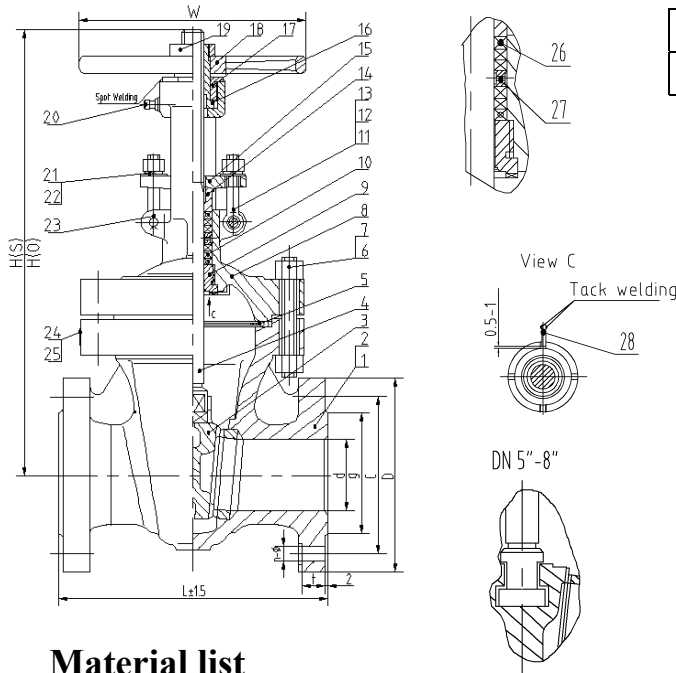

FIG.	Class	Material	Range
132.041	300LB	ASTM A216 WCB	2"-6"

Design acc. : API 600 .
Face to face : ANSI B16.10 .
Flange ends : ANSI B16.5 .
Pressure text : API 598 .
TA-Luft Packing
TA-Luft Gasket
Temperature range :
-29°C~ +425°C (ASTM A216 WCB)

Material list

NO.	Part	Material
		FIG. 132.041
1	Body	ASTM A216 WCB
2	Seat	ASTM A105+STL6
3	Disc	ASTM A216 WCB+13CR (ASTM A217 CA15 2"-4")
4	Stem	ASTM A182 F6a CL2
5	Gasket	TA-Luft Gasket
6	Bolt	ASTM A193 B7
7	Nut	ASTM A194 2H
8	Bonnet	ASTM A216 WCB
9	Seat ring	ASTM A276 410
10	Packing	TA-Luft packing
11	Pin	ASTM A29 1035
12	Nut	ASTM A194 2H
13	Bolt	ASTM A193 B7
14	Gland	ASTM A276 410
15	Gland flange	ASTM A216 WCB
16	Stem nut	ASTM A439 D-2
17	Cage nut	ASTM A29 1035
18	Handwheel	ASTM A536 60-40-18
19	Nut	ASTM A29 1035
20	Lubricator	ASTM A36
21	Spring washer	ASTM A29 1566
22	Washer	ASTM A36
23	Split pin	ASTM A36
24	Nameplate	ASTM A240 321
25	Rivet	ASTM A276 321
26	Packing	TA-Luft packing
27	Lantern	ASTM A276 410
28	Tabs	ASTM A105

Dimension List

Class	DN	d	g	C	D	t	n-Φ	L	W	H(S)	H(O)	Weight(kg)
300LB	2"	51	92.1	127	165	20.7	8-19	216	200	393	455	25.088
	3"	76	127	168.3	210	27	8-22	283	250	464.5	552	46.026
	4"	102	157.2	200	255	30.2	8-22	305	300	519	633	70.503
	6"	152	215.9	269.9	320	35	12-22	403	350	659	824	134.332

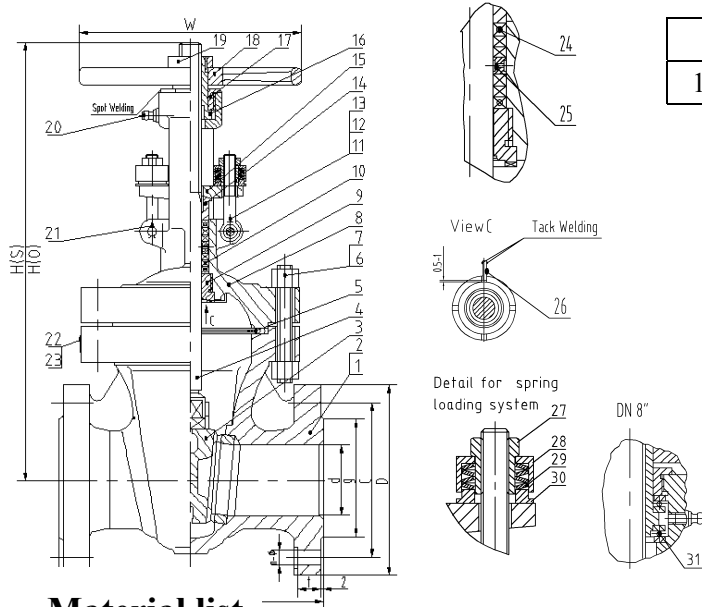

FIG.	Class	Material	Range
132.041	300LB	ASTM A216 WCB	8"

Design acc. : API 600 .
Face to face : ANSI B16.10 .
Flange ends : ANSI B16.5 .
Pressure text : API 598 .
TA-Luft Packing
TA-Luft Gasket
Temperature range :
-29°C~ +425°C (ASTM A216 WCB)

Material list

NO.	Part	Material
		FIG. 131.040
1	Body	ASTM A216 WCB
2	Seat	ASTM A105+STL6
3	Wedge	ASTM A216 WCB+13CR
4	Stem	ASTM A182 F6a CL2
5	Gasket	TA-Luft Gasket
6	Bolt	ASTM A193 B7
7	Nut	ASTM A194 2H
8	Bonnet	ASTM A216 WCB
9	Backseat	ASTM A276 410
10	Packing	TA-Luft packing
11	Pin	ASTM A29 1035
12	Nut	ASTM A194 2H
13	Bolt	ASTM A193 B7
14	Gland	ASTM A276 410
15	Gland flange	ASTM A216 WCB
16	Stem nut	ASTM A439 D-2
17	Cage nut	ASTM A29 1035
18	Handwheel	ASTM A536 60-40-18
19	Nut	ASTM A29 1035
20	Lubricator	ASTM A36
21	Split pin	ASTM A36
22	Nameplate	ASTM A240 321
23	Rivet	ASTM A276 321
24	Packing	TA-Luft packing
25	Lantern	ASTM A276 410
26	Tabs	ASTM A105
27	Nut	ASTM A276 420
28	Cover	ASTM A276 420
29	Spring	51CrV4
30	Gasket	ASTM A276 420
31	Bearing	

Dimension List

Class	DN	d	g	C	D	t	n-Φ	L	W	H(S)	H(O)	Weight(kg)
300LB	8"	203	269.9	330.2	380	39.7	12-25	419	450	806	1024	208.716

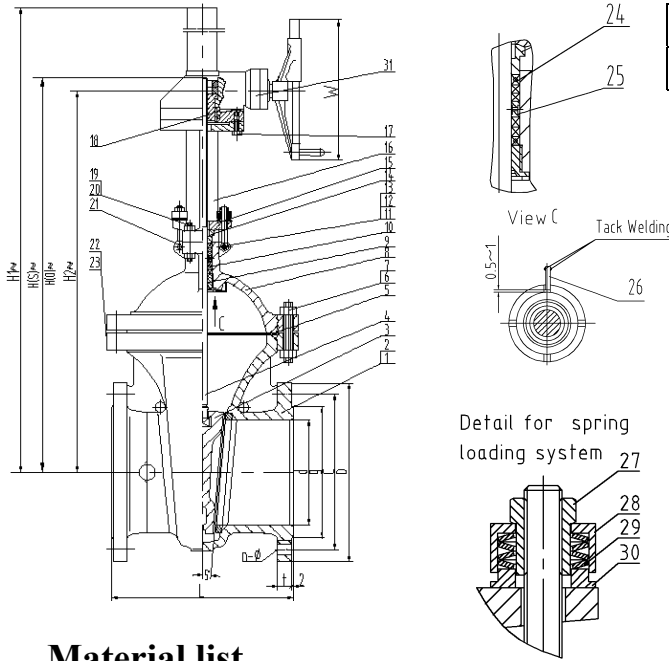

FIG.	Class	Material	Range
132.041	300LB	ASTM A216 WCB	10" - 20"

Design acc. : API 600 .
Face to face : ANSI B16.10 .
Flange ends : ANSI B16.5 .
Pressure text : API 598 .
TA-Luft Packing
TA-Luft Gasket
Temperature range :
-29°C ~ +425°C (ASTM A216 WCB)

Material list

NO.	Part	Material
		FIG. 131.040
1	Body	ASTM A216 WCB
2	Seat	ASTM A105+STL6
3	Wedge	ASTM A216 WCB+13CR
4	Stem	ASTM A182 F6a CL2
5	Gasket	TA-Luft Gasket
6	Bolt	ASTM A193 B7
7	Nut	ASTM A194 2H
8	Bonnet	ASTM A216 WCB
9	Backseat	ASTM A276 410
10	Packing	TA-Luft packing
11	Pin	ASTM A29 1035
12	Nut	ASTM A194 2H
13	Bolt	ASTM A193 B7
14	Gland	ASTM A276 410
15	Gland flange	ASTM A216 WCB
16	Yoke	ASTM A216 WCB
17	Bolt	ASTM A193 B7
18	Stem nut	
19	Bolt	ASTM A193 B7
20	Nut	ASTM A194 2H
21	Split pin	ASTM A36
22	Nameplate	ASTM A240 321
23	Rivet	ASTM A276 321
24	Packing	TA-Luft packing
25	Lantern	ASTM A276 410
26	Tabs	ASTM A105
27	Nut	ASTM A276 420
28	Cover	ASTM A276 420
29	Spring	51CrV4
30	Gasket	ASTM A276 420
31	Gear Box	

Dimension List

Class	DN	d	g	C	D	t	n-Φ	L	W	H(S)	H(O)	H1	H2	Weight(kg)
300LB	10"	254	323.8	387.4	445	46.1	16-29	457±2	310	956	1227.4	1277.4	921	325.546
	12"	305	381	450.8	520	49.3	16-32	502±3	310	1088	1412.4	1462.4	1065	421.321
	14"	337	412.8	514.4	585	52.4	20-32	762±3	460	1191	1545.5	1584	1188	615.713
	16"	387	469.9	571.5	650	55.6	20-35	838±3	460	1332	1740.5	1790	1191	831.391
	18"	432	533.4	628.6	710	58.8	24-35	914±3	610	1461	1917	1955	1404	1028.794
	20"	483	584.2	685.8	775	62	24-35	991±3	610	1600	2144	2153	1602	1276.248